

The Red Cross Quilt

A **BLOCKaWEEK** pattern from jinyybeyer.com

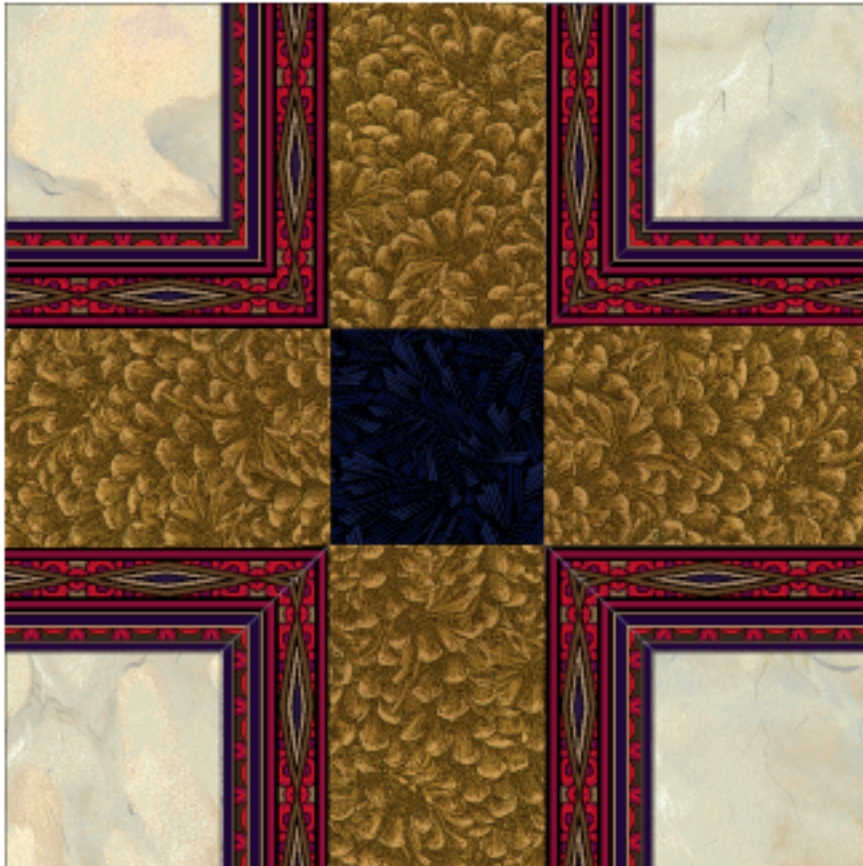

Kansas City Star, 1942

Template Guide

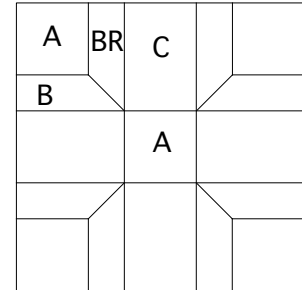

Fabric Placement

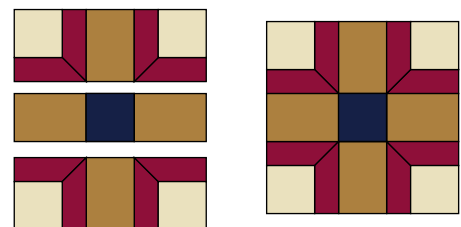
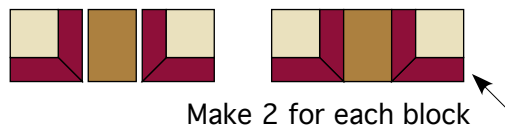
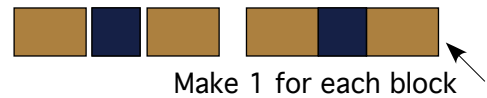
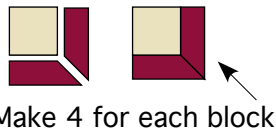
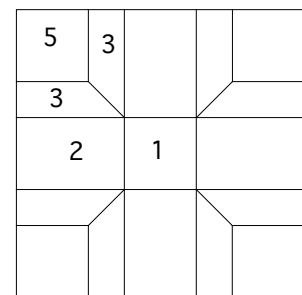

The fabrics used in this block are from the Jinny Beyer Palette Fabric Collection and other Jinny Beyer prints. Exact duplication of the block will depend on the availability of the prints. The design of the pattern shown here is a 10" block. Different fabric placement will occur when making the block in one of the other two sizes.

Block 0106



JINNY BEYER STUDIO 776 Walker Rd. GREAT FALLS, VA 22066
703-759-0250 FAX 703-759-0739 TOLL FREE: 866-760-7373 www.jinyybeyer.com

©Jinny Beyer, 2005

The Red Cross Quilt

A **BLOCKaWEEK** pattern from jinnybeyer.com

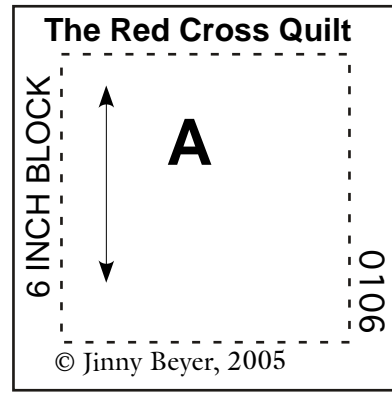
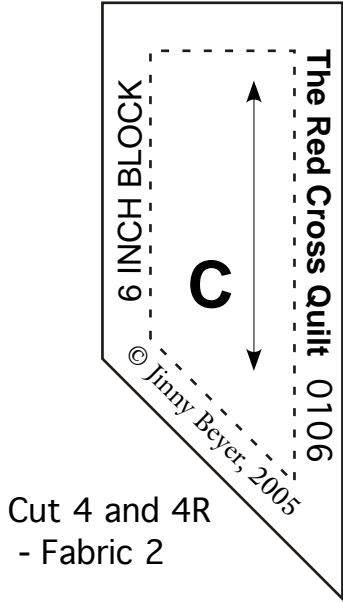

Cut 1 - Fabric 1
Cut 4 - Fabric 4

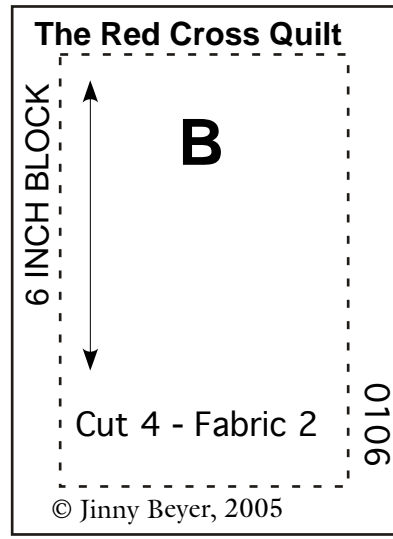

As drawn, templates should be placed on the right side of the fabric. After printing, check to make sure that the following line is two inches long.

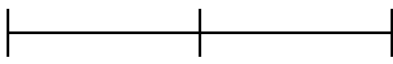

The Red Cross Quilt

A **BLOCKaWEEK** pattern from jinnybeyer.com

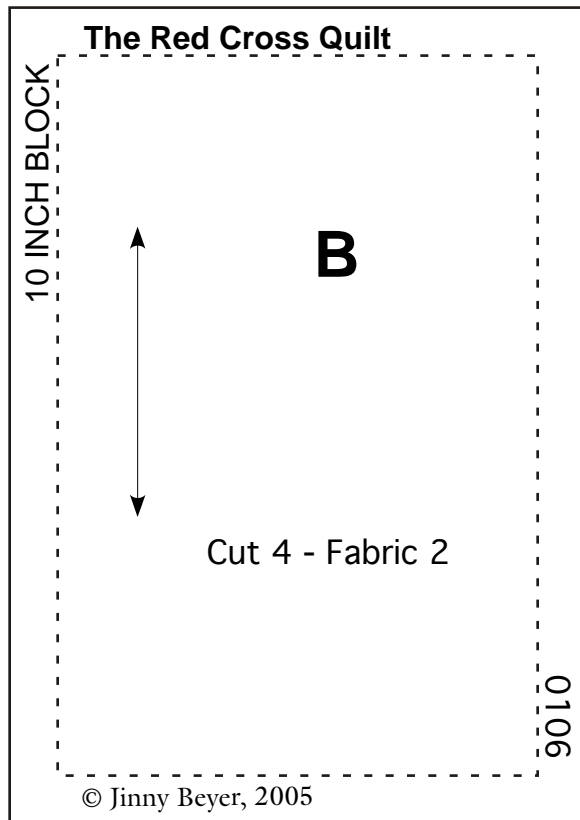
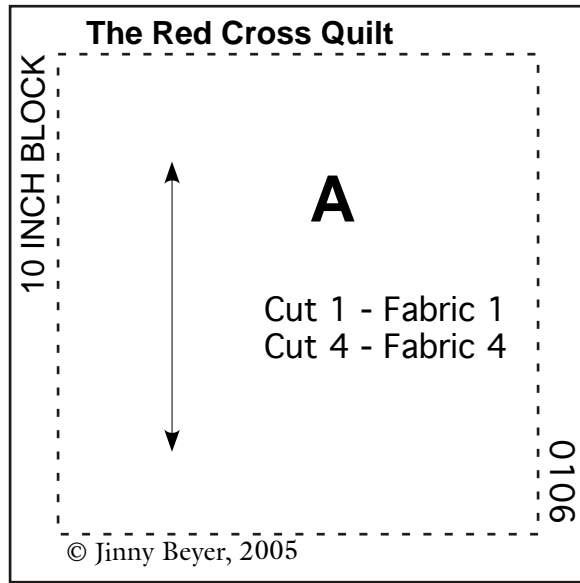
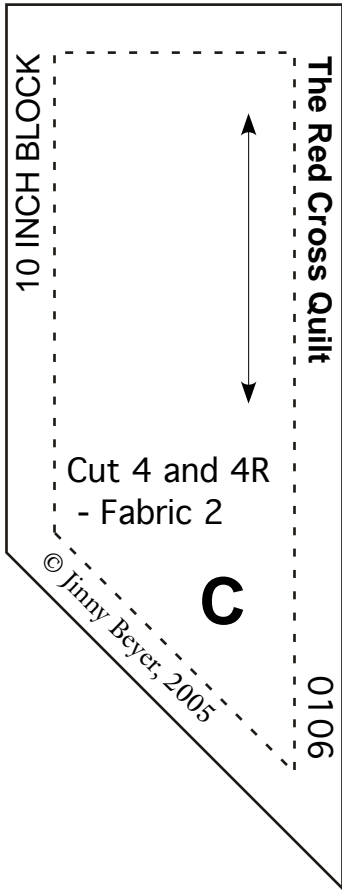

As drawn, templates should be placed on the right side of the fabric. After printing, check to make sure that the following line is two inches long.

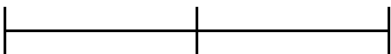

The Red Cross Quilt

A **BLOCKaWEEK** pattern from jinnybeyer.com

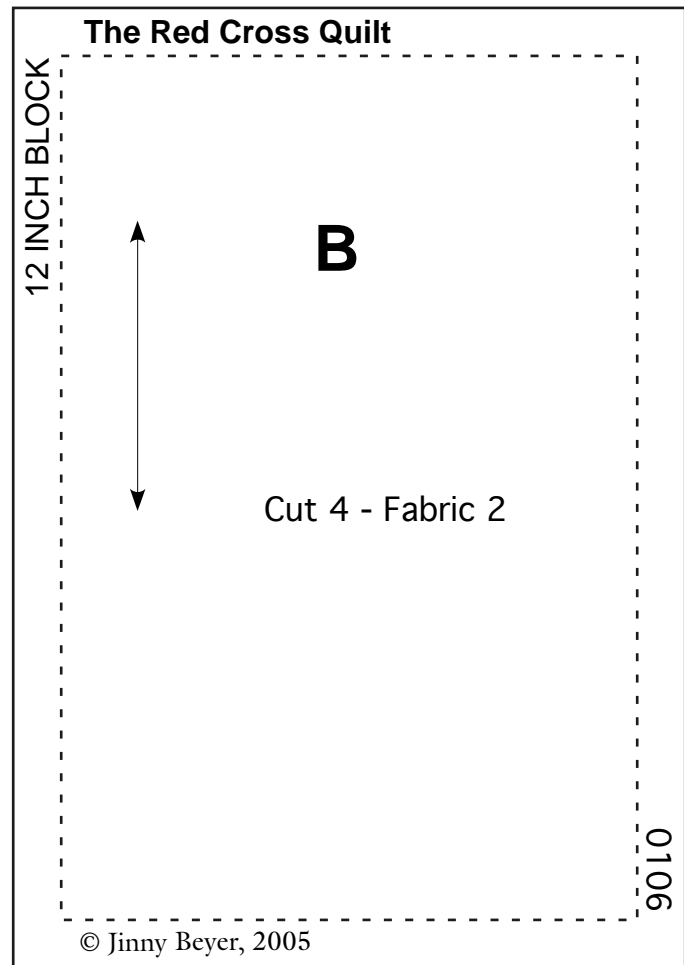
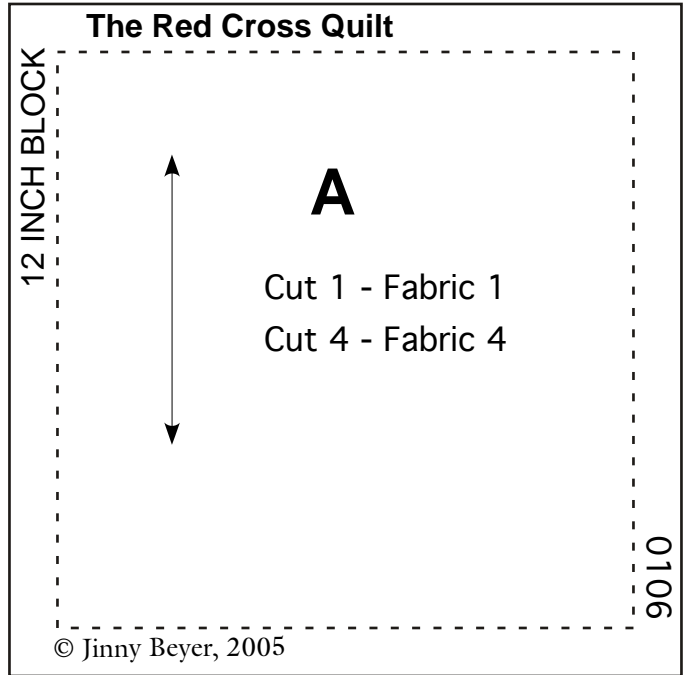
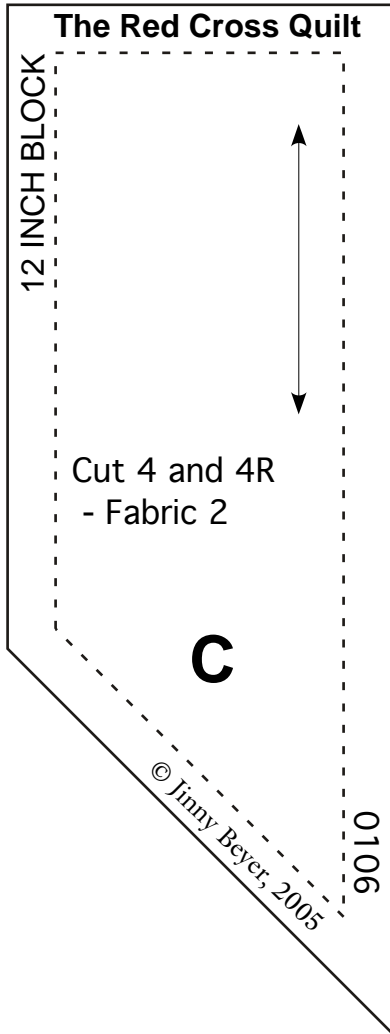

As drawn, templates should be placed on the right side of the fabric. After printing, check to make sure that the following line is two inches long.

