

CENTENNIAL

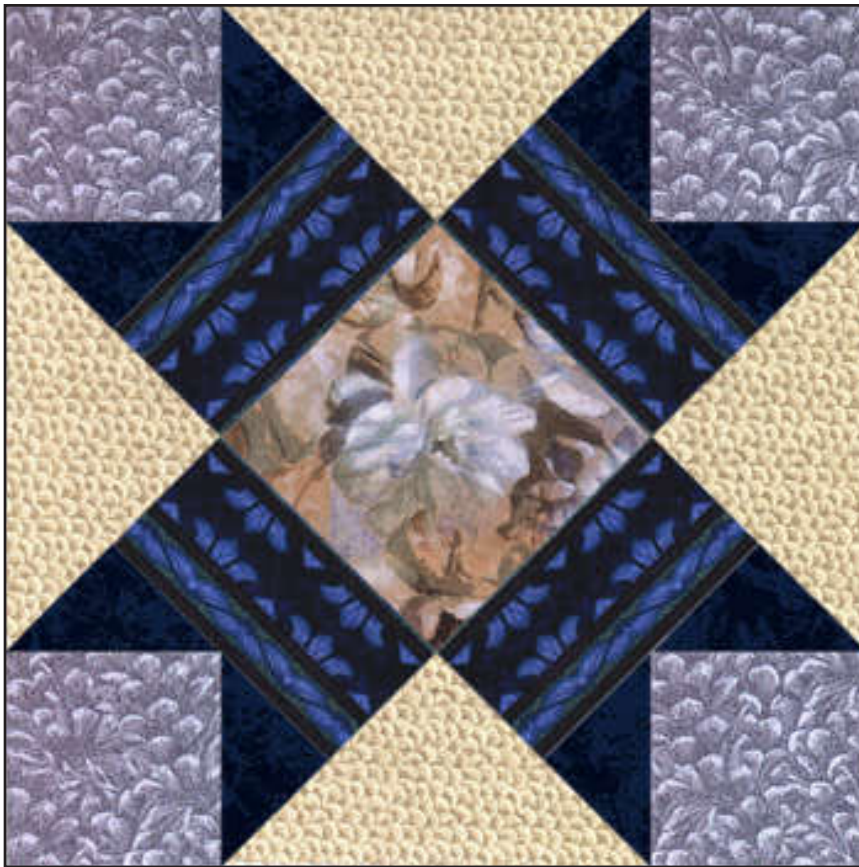

Ladies' Art Company Catalog, 1898

Template Guide

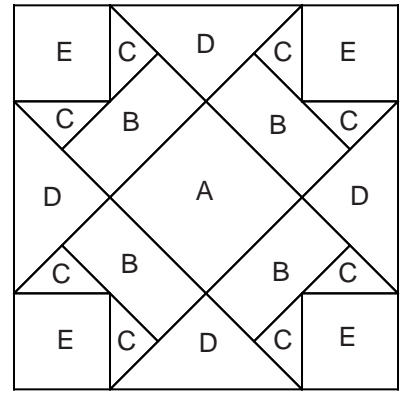

Fabric Placement

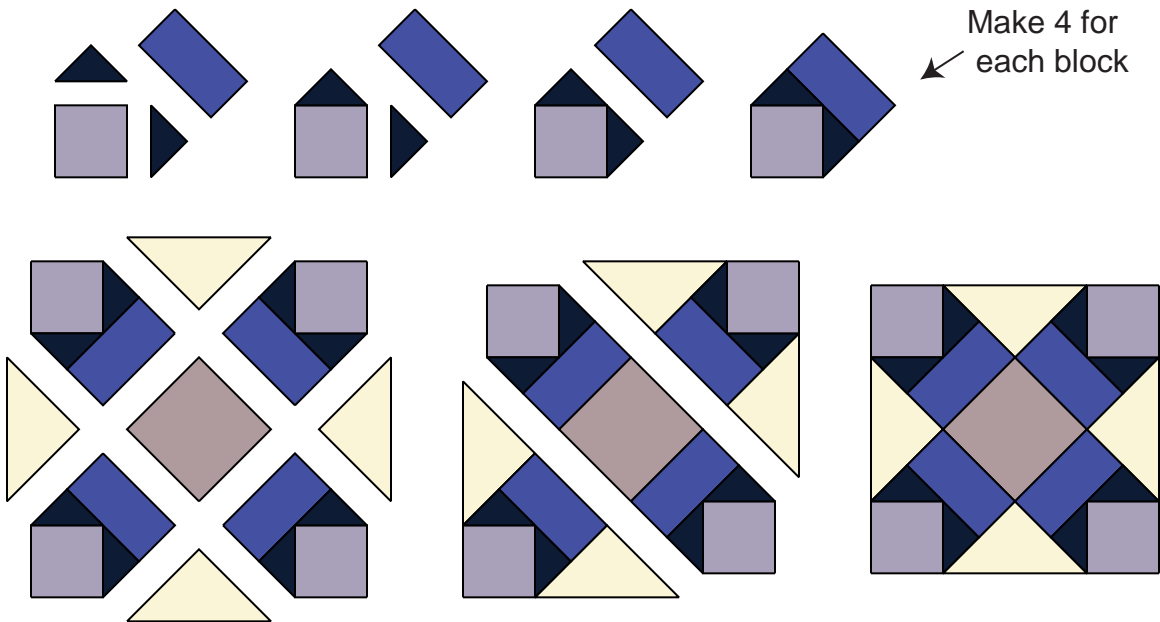
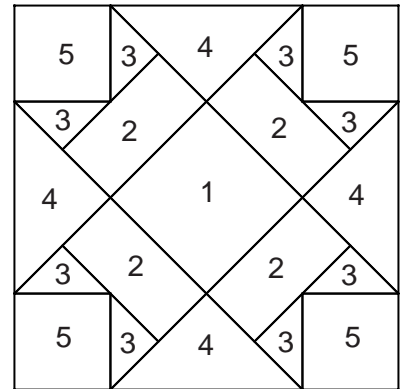

The fabrics used in this block are from the Jinny Beyer Palette Fabric Collection and other Jinny Beyer prints. Exact duplication of the block will depend on the availability of the prints. The design of the pattern shown here is a 10" block. Different fabric placement will occur when making the block in one of the other two sizes.



CENTENNIAL

Templates - 6" BLOCK

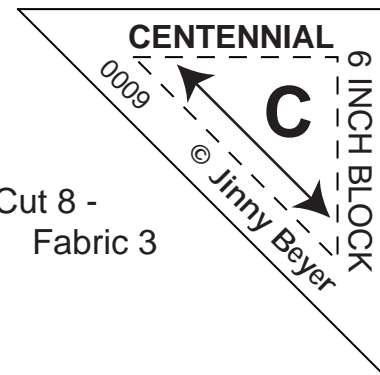
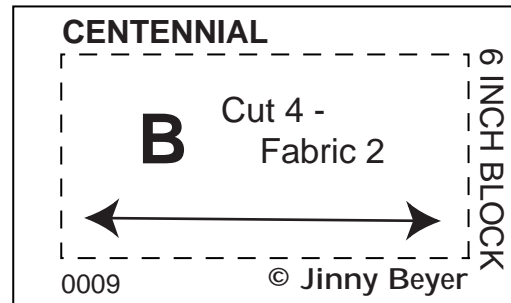
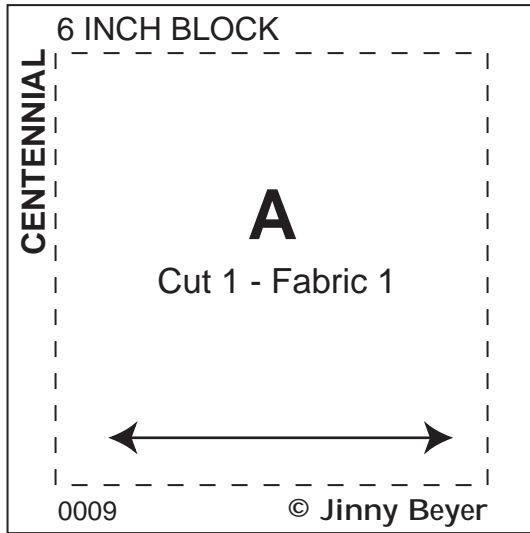

C - Cut 8 - Fabric 3

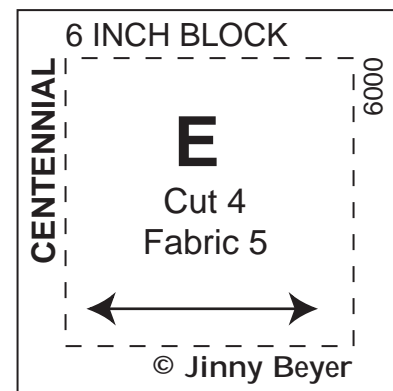
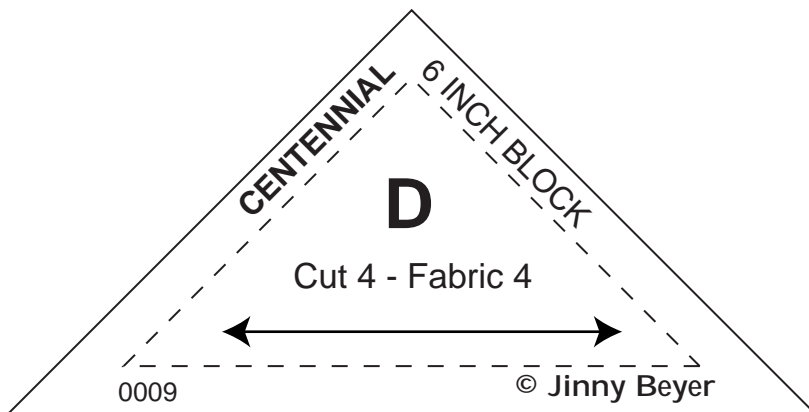

As drawn, templates should be placed on the right side of the fabric. After printing, check to make sure that the following line is two inches long.



CENTENNIAL

Templates - 10" BLOCK

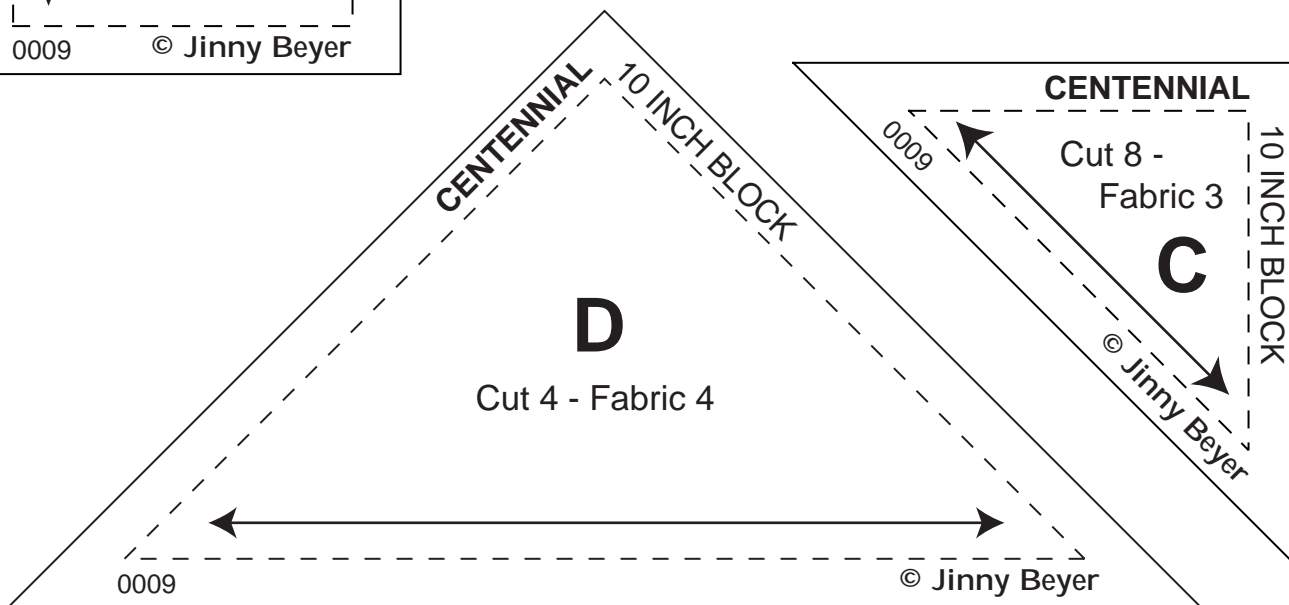
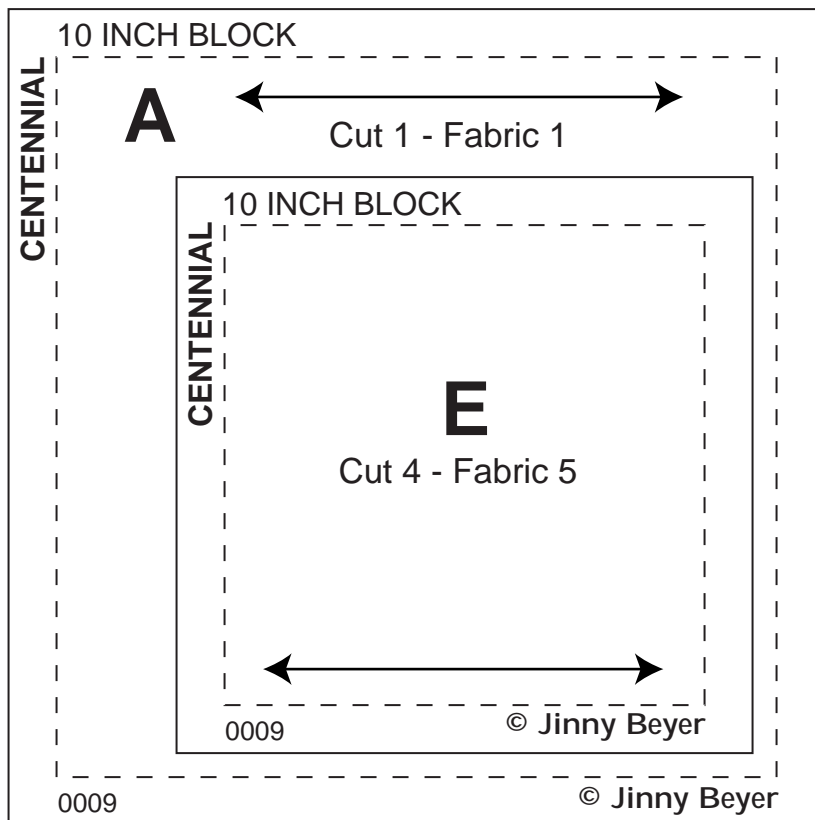
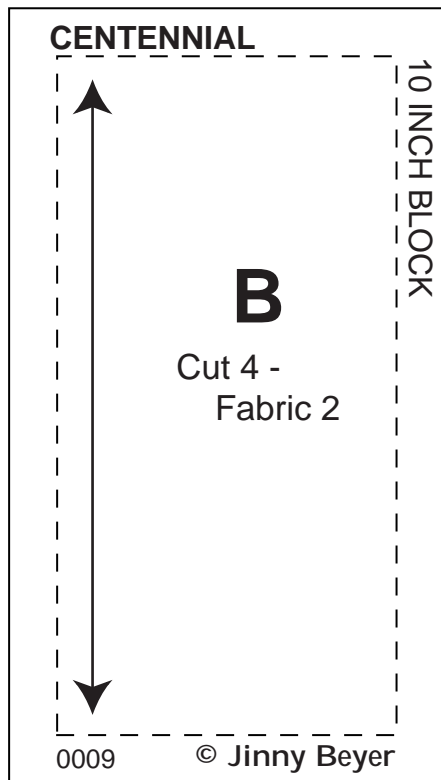

As drawn, templates should be placed on the right side of the fabric. After printing, check to make sure that the following line is two inches long.



CENTENNIAL

Templates - 12" BLOCK

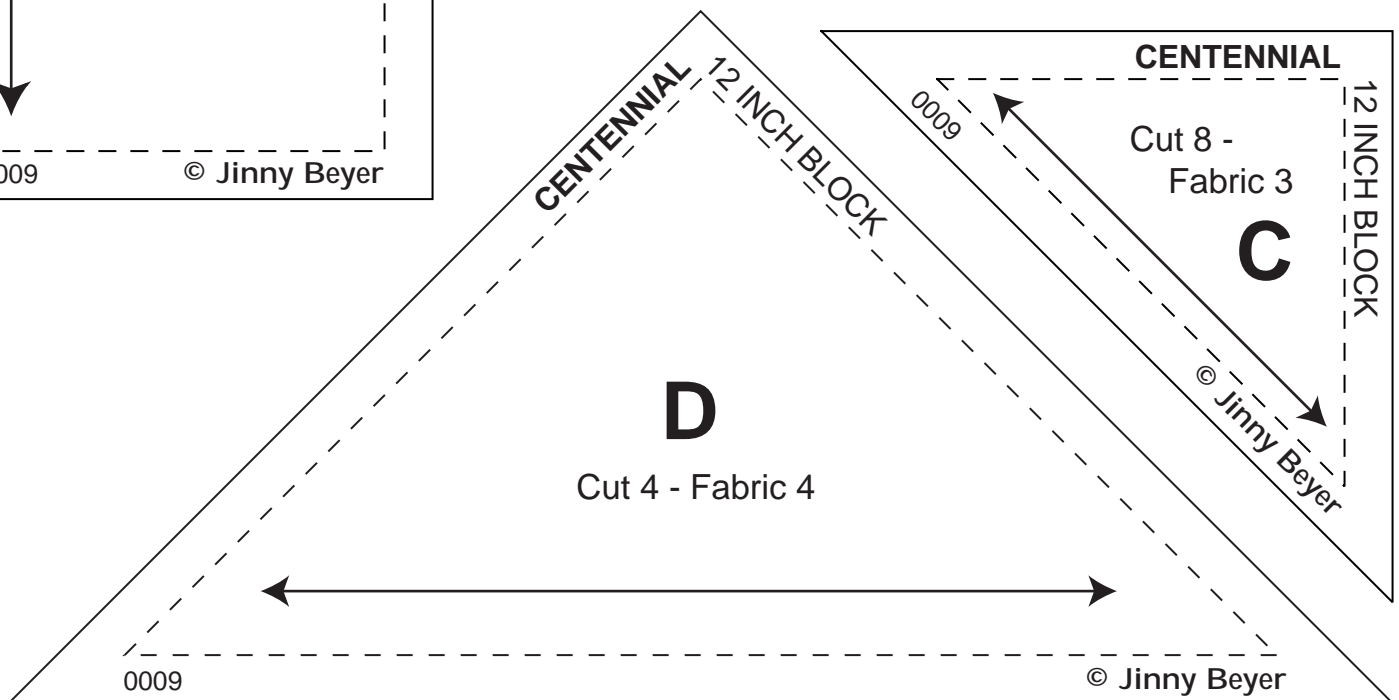
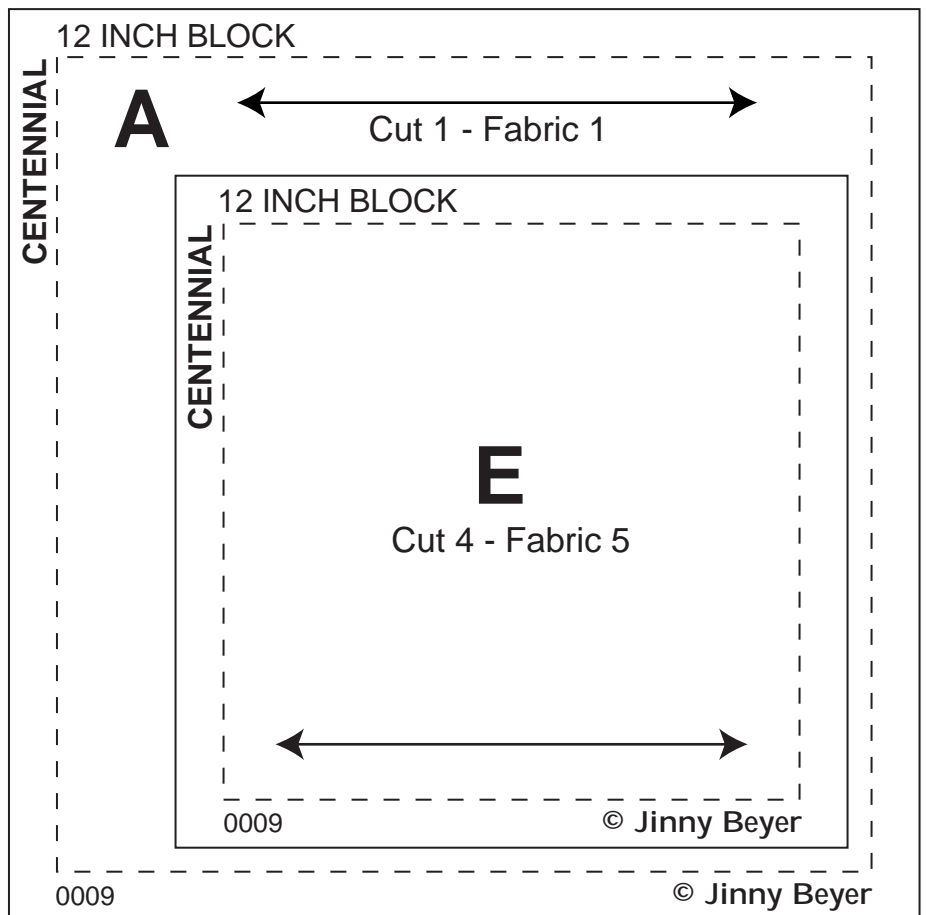
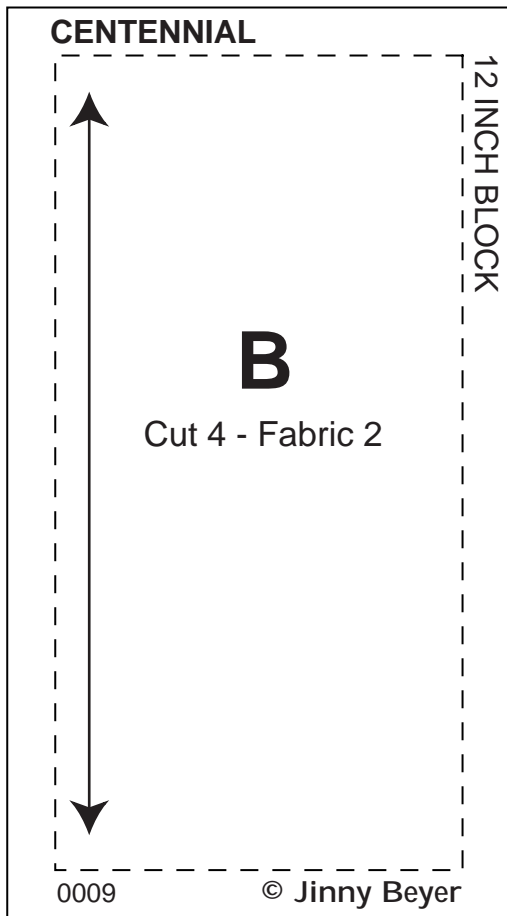

As drawn, templates should be placed on the right side of the fabric. After printing, check to make sure that the following line is two inches long.

